

120W LED Underwater Boat Light PUD210-120W

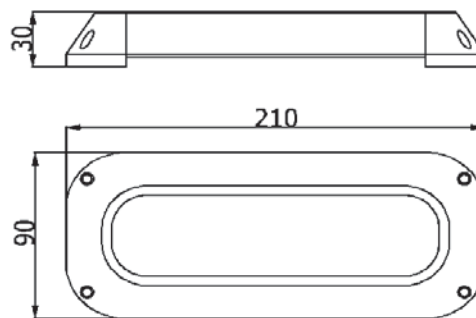

L210 x W90 x H25MM

■ Main Features:

1. Made of 316L stainless Steel has excellent corrosion-proof
2. Waterproof: IP68
3. Low power consumption, high efficiency
4. CE and RoHS approved
5. Every light comes with 2M cable, 4 M4 screws and 1 fast fuse
6. Built-in driver
7. Easy to Install

Power (W)	Emitting color	Chips Brand	Working Current	Input voltage	Wavelength (nm)	Total Lumens (LM)	Beam Angle
12x10	White	CREE	8A	DC10-30V	--	8000-9000	90°x10°
	Red				630	3000-4000	
	Green				520	5000-6000	
	Blue				460	2000-3000	
	RGB		8A / 4A	DC12V/DC24V	--	4000-4500	
	RGBW				--	4500-5000	

160W LED Underwater Boat Light PUD119-160W

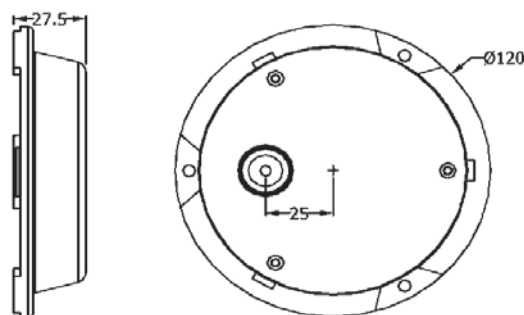

Diameter 120MM x Height 27.5MM

■ Main Features:

1. Made of 316L stainless Steel has excellent corrosion-proof
2. Waterproof: IP68
3. Low power consumption, high efficiency
4. CE and RoHS approved
5. Every light comes with 2M cable, 3 M4 screws and 1 fast fuse
6. Built-in driver
7. Easy to Install

Power (W)	Emitting color	Chips Brand	Working Current	Input voltage	Wavelength (nm)	Total Lumens (LM)	Beam Angle
8x10	White	Epistar	5A	DC10-30V	--	5000-6000	90°x10°
	Red				630	2000-2500	
	Green				520	3000-4000	
	Blue				460	1000-1500	
	RGB		5A / 2.5A	DC12V/DC24V	--	2500-3000	
	RGBW				--	3000-3500	